

bimos

# / ALL-IN-ONE

9630 / 9633 / 9631 / 9640  
9643 / 9641

MONTAGE- UND  
BEDIENUNGSANLEITUNG  
ASSEMBLY AND OPERATING  
INSTRUCTIONS



**bimos** - eine Marke der  
Interstuhl Büromöbel GmbH & Co. KG  
Brühlstraße 21  
72469 Meßstetten-Tieringen  
Phone +49 7436 871-0  
Fax +49 7436 871-359  
info@bimos.de  
www.bimos.de

Ident. - Nr. 34002.0000.01

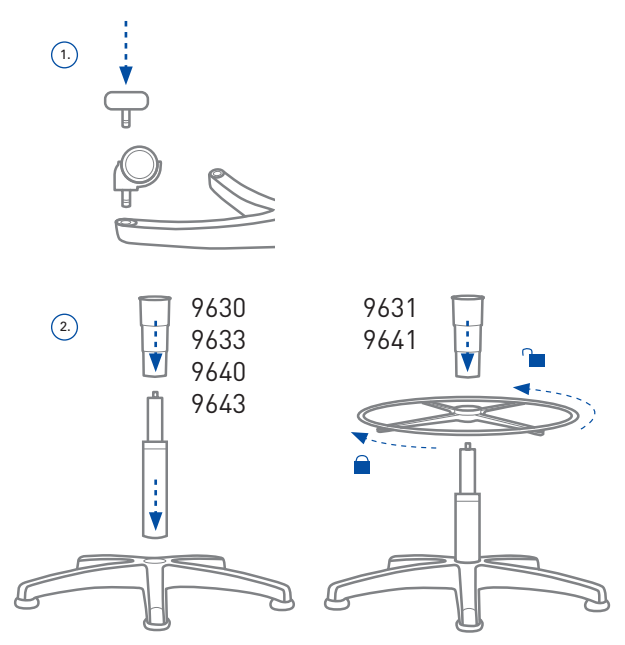
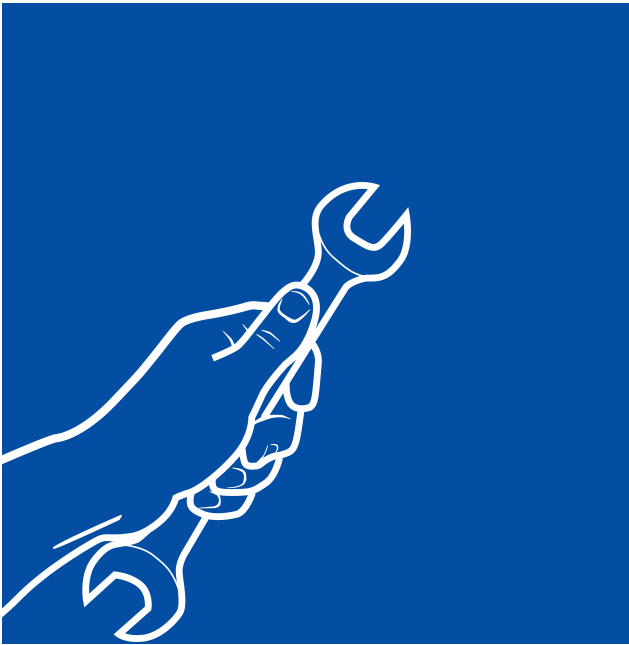

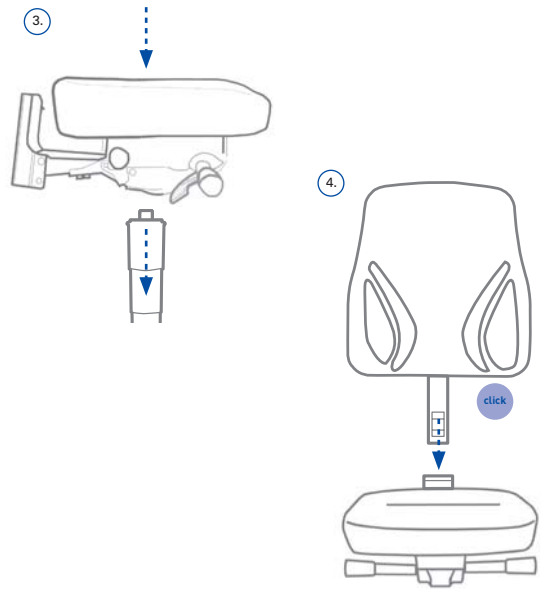
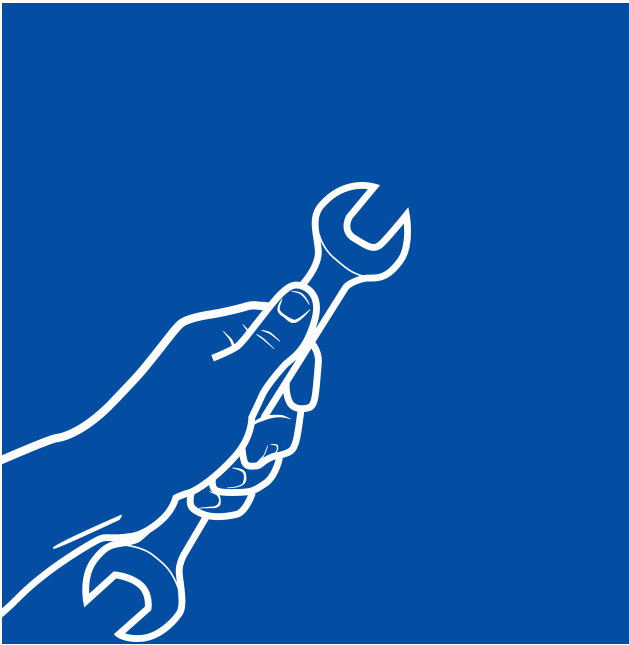

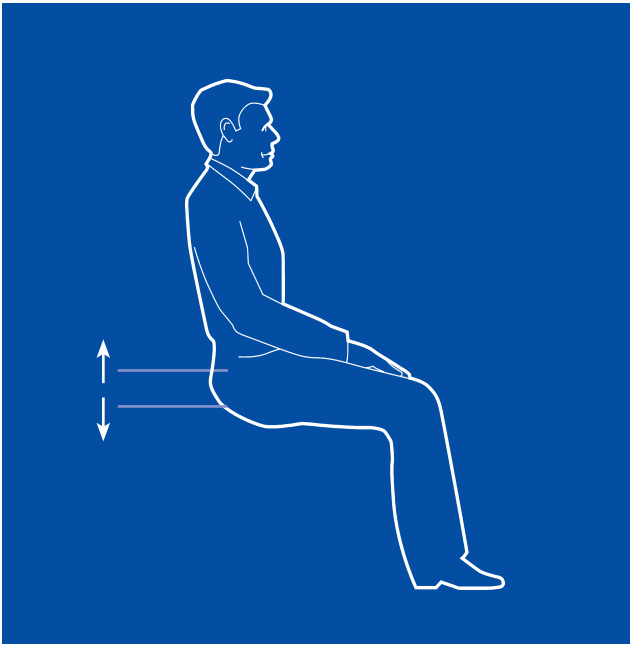



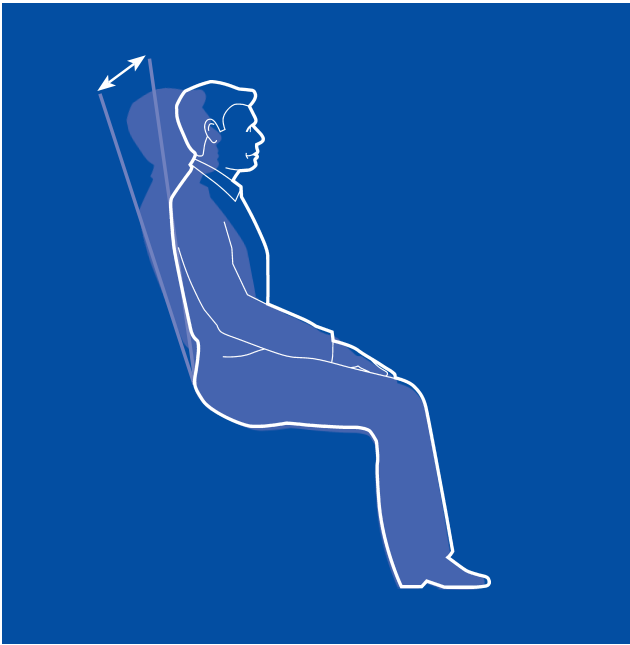

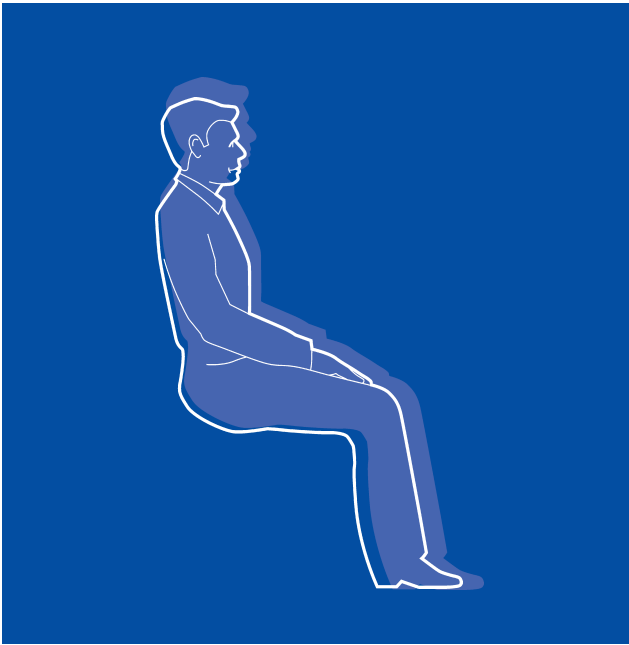

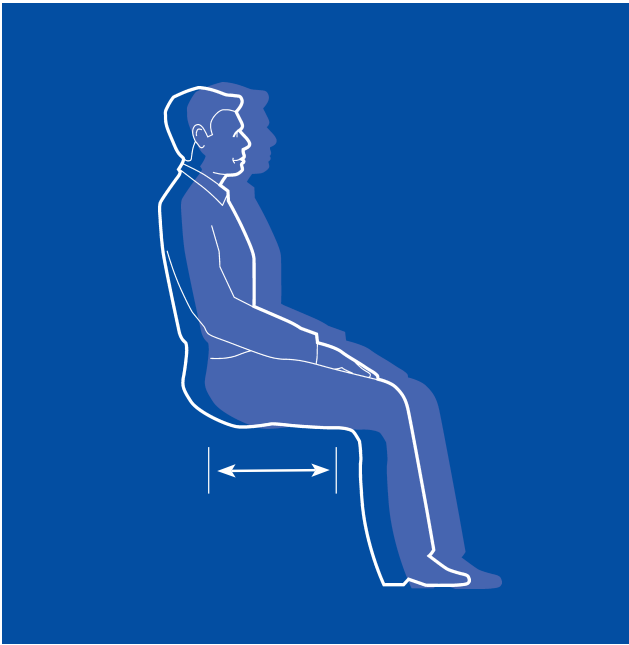



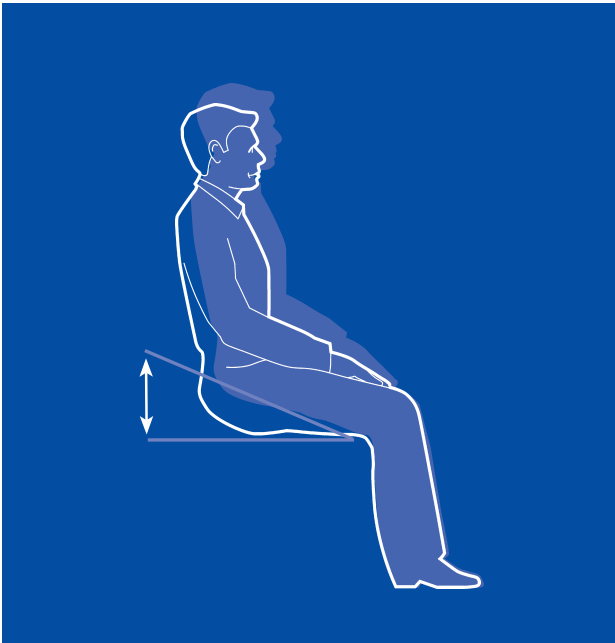

9631 / 9641

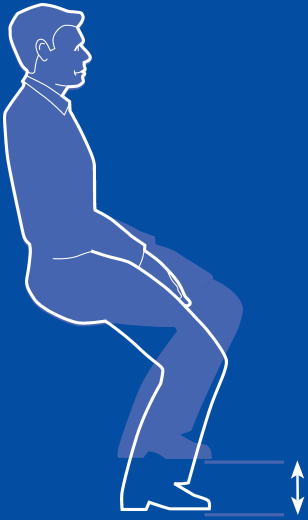



Garantie  
**5**  
Jahre



**DIN**  
**68877**



9630

9633

9631



9640

9643

9641

**ALL-IN-ONE**

